

Upchurch® LOW PRESSURE FITTINGS AND CONNECTORS





FLANGELESS FITTINGS

For Flat-Bottom Ports

Upchurch Scientific® Flangeless Fittings eliminate the need to flange tubing. This removable and reusable system provides several benefits:

Convenience: Our Flangeless Fittings are easy to replace. Just slip the nut and ferrule over the tubing and finger tighten the nut.

Minimal Down-Time: Component replacement is quick, taking only a few seconds — unlike the significant time required to flange tubing.

Cost-Effectiveness: Repairing a flanged tubing assembly requires a costly flanging tool or the purchase of a complete replacement assembly, including a new length of tubing and a set of fittings. The Flangeless Fittings system typically requires only one new ferrule at minimal cost.

Our 1/4-28 Flangeless Fittings for 1/16" and 1/8" OD tubing are summarized on this page. For our Metric and Large Bore Flangeless Fittings, respectively.

Dimensions for 1/4-28 Flangeless Fittings

(pages 56 and 57)

Nuts

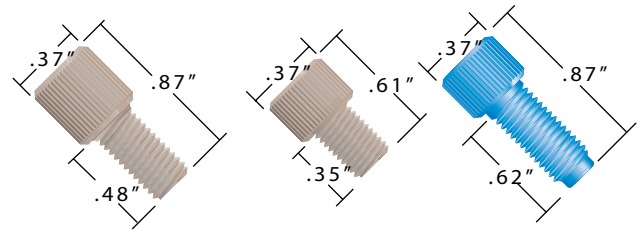

Standard	Short	Extra-Long Threaded
P-20, P-206, P-30, P-306	P-208	P-210
P-220, P-320	P-218	
P-230, P-330	P-235	
P-238, P-338	P-308	
P-245, P-345	P-335	
P-245B		

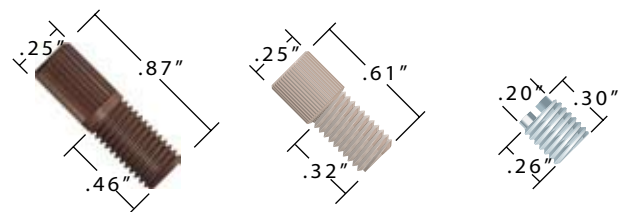

Headless	Short Headless	FlushNuts™
P-286, P-386	P-283, P-348	F-358, F-368

Ferrules

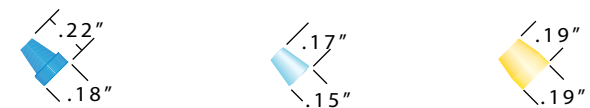

Standard 1/16"	Small Valve 1/16"	Standard 1/8"
P-200, P-200N, P-200R, P-221	P-240	P-300, P-300N

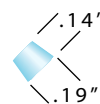

Small Valve 1/8"
P-340

The Convenience of Flangeless Fittings:

Our Flangeless Nut provides fingertight convenience – no wrenches required.

Our Flangeless Ferrule provides a leak-proof seal. There is no need to spend time flanging tubing.

Flangeless Ferrule Pressure Ratings:

P-200 ETFE Ferrule for 1/16" OD Tubing (using a P-201 Delrin® Nut)	Tefzel® (ETFE) Tubing PEEK™ Tubing Stainless Steel Tubing	2,500 psi (172 bar) 3,000 psi (207 bar) 2,200 psi (152 bar)
P-240 ETFE Ferrule for 1/16" OD Tubing (using a P-201 Delrin Nut)	ETFE Tubing PEEK Tubing Stainless Steel Tubing	2,600 psi (179 bar) 2,500 psi (172 bar) 2,800 psi (193 bar)
P-300 ETFE Ferrule for 1/8" OD Tubing (using a P-301 Delrin Nut)	ETFE Tubing PEEK Tubing	1,900 psi (131 bar) 600 psi (41 bar)
P-340 ETFE Ferrule for 1/8" OD Tubing (using a P-301 Delrin Nut)	ETFE Tubing PEEK Tubing Stainless Steel Tubing	3,000 psi (207 bar) 600 psi (41 bar) 1,200 psi (83 bar)

These tests were performed at room temperature with water testing the fitting, NOT the tubing. The material of the nuts, ferrule, tubing and port can affect your results.

FLANGELESS FITTINGS FOR 1/16" OD TUBING

For Flat-Bottom Ports

* **Stainless Steel, Delrin®, PEEK™, Teflon®, Tefzel® (ETFE), Polypropylene and PPS Nuts**

* **ETFE and Polypropylene Ferrules**

Upchurch Scientific® Flangeless Ferrules and wide assortment of Flangeless Nuts are excellent replacements for flanged fittings. Flangeless Fittings are dependable, easy to use and easy to replace. For those tight-space applications where nut heads often interfere with each other, try our FlushNut™ Fittings and Tightening Tools. For more information on these innovative products.

All nuts on this page have 1/4-28 threads, except LT-111, which has 10-32 threads. Nuts are available in a wide variety of materials, and ferrules are available in ETFE and polypropylene.

The P-200R Ferrule has an enhanced sealing surface to ensure a better seal for gas applications. Please Note: For even better performance in gas applications, try using our Super Flangeless™ Fittings or our VacuTight™ Fittings.

The designs of many small, low-pressure valves incorporate very shallow ports. The P-240 Ferrule is designed to seal tightly in such ports. The special sealing ring on this ferrule helps ensure a minimum dead-volume seal between the tubing, ferrule and port.

Please Note: some receiving ports, especially machined ports, lack sufficient threading to allow effective use of the P-240 Ferrule. Use our standard P-200, P-200N or P-221 Ferrules if you experience difficulties.

NUT TIGHTENING TOOLS

Use the P-298, P-299 or P-399 Flangeless Nut Extender Tool to tighten any standard, short or extra long style nuts in hard-to-reach places. For headless nuts, use the P-297 Tool. These tools can be used to tighten any of the knurl-headed nuts. They can also be used with many of the high pressure nuts. The F-346 is for tightening 1/4-28 FlushNut Fittings.



P-200
ETFE Ferrule



P-200N
ETFE Ferrule



P-200R
ETFE Gas Ferrule



P-221
Polypropylene Ferrule



P-240
ETFE Small Valve Ferrule

Sealing Ring



F-358
Stainless Steel
FlushNut



P-202
Delrin Nut

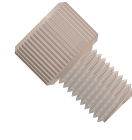

P-235
PEEK Nut

Please see page 55 for the dimensions of the products on this page.

FLANGELESS FERRULES FOR 1/16" OD TUBING Qty.

P-200x	Flangeless Ferrules	Blue ETFE	10-pk
P-200Nx	Flangeless Ferrules	Natural ETFE	10-pk
P-200R	Flangeless Ferrule	Red ETFE	ea.
P-221	Flangeless Ferrule	Natural Polypropylene	ea.
P-240x	Small Valve Flangeless Ferrules	Natural ETFE	10-pk

1/4-28 FLANGELESS NUTS FOR 1/16" OD TUBING* Qty.

F-358x	Flangeless FlushNuts	Stainless Steel	10-pk
LT-111x	Flangeless Nuts, 10-32 use only with P-240 Ferrule	Natural PEEK	10-pk
P-201x	Flangeless Nuts	Black Delrin	10-pk
P-202x	Flangeless Nuts	Red Delrin	10-pk
P-203x	Flangeless Nuts	White Delrin	10-pk
P-204x	Flangeless Nuts	Cream Delrin	10-pk
P-205x	Flangeless Nuts	Green Delrin	10-pk
P-206x	Flangeless Nuts	Blue Delrin	10-pk
P-208x	Short Flangeless Nuts	Black Delrin	10-pk
P-210x	Extra Long Flangeless Nuts for Dionex® systems	Blue ETFE	10-pk
P-218x	Short Flangeless Nuts	Natural ETFE	10-pk
P-218BLKx	Short Flangeless Nuts	Black ETFE	10-pk
P-220x	Flangeless Nuts	Natural Polypropylene	10-pk
P-230x	Flangeless Nuts	Natural PEEK	10-pk
P-235x	Short Flangeless Nuts	Natural PEEK	10-pk
P-238x	Flangeless Nuts	Purple Delrin	10-pk
P-245x	Flangeless Nuts	Natural Teflon PFA	10-pk
P-245Bx	Flangeless Nuts	Blue Teflon PFA	10-pk
P-283x	Short Headless Flangeless Nuts	Natural PEEK	10-pk
P-286	Headless Flangeless Nut	Natural PPS	ea.

NUT TIGHTENING TOOLS

F-346	FlushNut Tool for 1/4-28 Nuts
P-297	Flangeless Nut Extender Tool for Headless Style Nuts, Aluminum
P-298	Flangeless Nut Extender Tool for Standard Head Nuts, Delrin
P-299	Flangeless Nut Extender Tool for Standard Head Nuts, Aluminum
P-399	Flangeless Nut Extender Tool for Standard Head Nuts, Short, Aluminum

*Other color choices are available for several of these nuts. Please contact us for more information.



FLANGELESS FITTINGS FOR 1/8" OD TUBING

For Flat-Bottom Ports

* Stainless Steel, Delrin®, Polypropylene, PEEK™, Tefzel® (ETFE), Teflon® and PPS Nuts

* Tefzel (ETFE) Ferrules

The P-300 and P-300N Flangeless Ferrules provide an easy solution when connecting 1/8" OD tubing to 1/4-28 (and M6) flat-bottom ports, without the need to flange the tubing ends. The P-340 is a short ferrule with a built-in sealing ring, which is especially well suited for ports with shallow thread depths, commonly found in low pressure valves (see note, below).

Upchurch Scientific® offers several standard-length and short nut options, manufactured from a variety of polymers. One popular option is our "headless" design. With a slimmer head design, headless nuts are ideal for use in tight places. The PEEK and polyphenylene sulfide (PPS) materials that comprise these streamlined nuts offer excellent chemical resistance and thread integrity.

For an even more streamlined design, try our F-368 FlushNut™. When tightened with the F-346 tool, this nut stops at or near flush with the top of the receiving port. For more information on these products.

All nuts on this page have 1/4-28 threads. Nuts for M6 threaded ports.

Please Note: some receiving ports, especially machined ports, lack sufficient threading to allow effective use of the P-340 Ferrule. Use our standard P-300 or P-300N Ferrules if you experience difficulties.



P-300
ETFE Ferrule



P-300N
ETFE Ferrule



P-340
ETFE Small Valve Ferrule



F-368
Stainless Steel
FlushNut



P-305
Delrin Nut

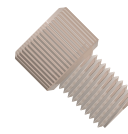

P-335
PEEK Nut

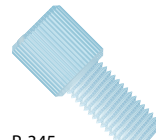

P-345
Teflon Nut



P-386
PPS Nut

Please see page 55 for the dimensions of the products on this page.

LOCK NUT

The P-312 Lock Nut is for use with any 1/4-28 male Flangeless Fitting. Use this product in applications where vibrations can loosen fittings.



P-312
Lock Nut
White Delrin

To Use: Thread the lock nut onto the male fitting. When the male fitting is firmly seated into the receiving port, tighten the lock nut down against the receiving port to securely hold the male fitting in place.

Note

Other Flangeless Fittings Innovations

>> The Flangeless SealTight™ Fittings system holds to 5,000 psi (345 bar) in a flat-bottom port.

>> Super Flangeless™ Fittings hold to high pressures and prevent tubing twist.

>> VacuTight™ Fittings are designed to improve transfer volume consistency in gas and liquid handling systems.

>> Our Frit-In-A-Ferrule™ seals and filters simultaneously.

Capillary Connections

>> Connect capillary-sized tubing to 1/4-28 or M6 flat-bottom ports using our Super Flangeless Fittings, along with NanoTight™ Sleeves.

FLANGELESS FERRULES FOR 1/8" OD TUBING Qty.

P-300x	Flangeless Ferrules	Yellow ETFE	10-pk
P-300Nx	Flangeless Ferrules	Natural ETFE	10-pk
P-340x	Small Valve Ferrules	Natural ETFE	10-pk

1/4-28 FLANGELESS NUTS FOR 1/8" OD TUBING* Qty.

F-368x	Flangeless FlushNuts	Stainless Steel	10-pk
P-301x	Flangeless Nuts	Black Delrin	10-pk
P-302x	Flangeless Nuts	Red Delrin	10-pk
P-303x	Flangeless Nuts	White Delrin	10-pk
P-304x	Flangeless Nuts	Cream Delrin	10-pk
P-305x	Flangeless Nuts	Green Delrin	10-pk
P-306x	Flangeless Nuts	Blue Delrin	10-pk
P-308x	Short Flangeless Nuts	Black Delrin	10-pk
P-315x	Flangeless Nuts	Natural ETFE	10-pk
P-320x	Flangeless Nuts	Natural Polypropylene	10-pk
P-330x	Flangeless Nuts	Natural PEEK	10-pk
P-335x	Short Flangeless Nuts	Natural PEEK	10-pk
P-338x	Flangeless Nuts	Purple Delrin	10-pk
P-345x	Flangeless Nuts	Natural Teflon PFA	10-pk
P-348x	Short Headless Flangeless Nuts	Natural PEEK	10-pk
P-386	Headless Flangeless Nut	Natural PPS	ea.

LOCK NUT FOR FLANGELESS NUTS Qty.

P-312x	Lock Nut for Flangeless Nuts	White Delrin	10-pk
--------	------------------------------	--------------	-------

*Other color choices are available for several of these nuts. Please contact us for more information.



METRIC FLANGELESS FITTINGS

For Flat-Bottom Ports

* For 1/16", 1.8mm, 2.0mm, 2.5mm, 3.0mm, 4.0mm and 1/8" OD Tubing

* Delrin®, Teflon®, PPS and PEEK™ Nuts

* Tefzel® (ETFE) and Kel-F® Ferrules

Upchurch Scientific® Metric Flangeless Ferrules are designed to connect 1.8, 2.0, 2.5, 3.0 and 4.0mm OD tubing to flat-bottom ports when paired with the appropriate M6, 1/4-28 or 5/16-24 Flangeless Nuts. We also offer M6-threaded nuts to connect 1/16" and 1/8" OD tubing, plus a tubing sleeve to facilitate 1.0mm OD tubing connections. Please refer to the "Metric Connections" chart on this page for information regarding which nuts and ferrules to use with your tubing.

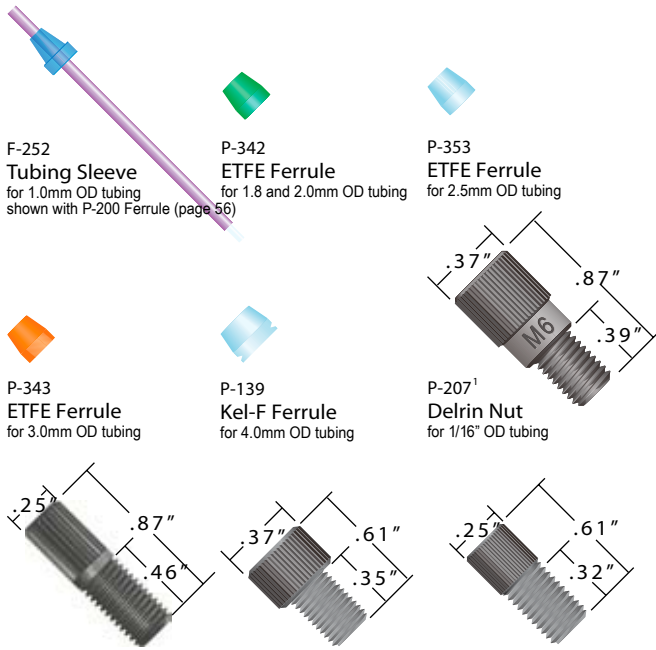

P-288
PPS Nut
for 1/16" OD tubing

P-347²
PEEK Nut
for 1.8, 2.0, 3.0mm
and 1/8" OD tubing

P-362
PEEK Nut
for 1.8, 2.0, 3.0mm and
1/8" OD tubing

¹The dimensions shown apply to P-207, P-226, P-307 and P-326.

²The dimensions shown apply to P-207S, P-247, P-307S and P-347.

More Metric-Sized Products:

	Page
High Pressure Polymer Fittings	13, 19, 20, 42
High Pressure Stainless Steel Fittings	15
Luer Adapters	47
Metric Threaded Adapters	52
External NPT Adapters	53
VacuTight™ Fittings	59
Plugs and Caps	60
Low Pressure Unions	62
Bulkhead Unions	63
PEEK (1.8mm OD and Capillary) and Fused Silica Tubing	66, 67
PEEKsil™ Tubing	68
Teflon Tubing (1.4mm OD FEP and Capillary PFA)	71, 72
Frit-In-A-Ferrule™	121

In addition, many of our 1/4-28 threaded Filters, Valves and Flow Control Accessories can be converted to accept 1.8, 2.0, 2.5 and 3.0mm tubing, using the ferrules listed for 1/4-28 ports in the "Metric Connections" table, above right.

Metric Connections:

Use this chart to determine the low pressure fittings needed to connect metric and English-sized tubing into the indicated ports.

Tubing Size	Port	Ferrules	Nuts
1.0mm	M6	Any 1/16" ferrule from page 56*	P-207, P-207S, P-226, P-247, P-288
	1/4-28	Any 1/16" ferrule from page 56*	Any 1/4-28 nut from page 56
1.8mm	M6	P-342	P-307, P-307S, P-326, P-347, P-362
	1/4-28	P-342	Any nut from page 57
2.0mm	M6	P-342	P-307, P-307S, P-326, P-347, P-362
	1/4-28	P-342	Any nut from page 57
2.5mm	M6	P-353	P-307, P-307S, P-326, P-347, P-362
	1/4-28	P-353	Any nut from page 57
3.0mm	M6	P-343	P-307, P-307S, P-326, P-347, P-362
	1/4-28	P-343	Any nut from page 57
4.0mm	5/16-24	P-139	P-132, P-138 from page 61
1/16"	M6	Any 1/16" ferrule from page 56	P-207, P-207S, P-226, P-247, P-288
	M6	P-840 from page 59	P-931, P-933, P-935 from page 59
1/8"	M6	Any 1/8" ferrule from page 57	P-307, P-307S, P-326, P-347, P-362
	M6	P-940 from page 59	P-943, P-945, P-947 from page 59

*with F-252 Tubing Sleeve.

Metric Ferrule Pressure Ratings:

	Polymer Tubing	
1.0mm OD Tubing	FEP	500 psi (34 bar)*
P-200 Flangeless Ferrule (using a P-207 Delrin Nut, F-252 Tubing Sleeve)		
1.8-2.0mm OD Tubing	PEEK	1,700 psi (117 bar)
P-342 Flangeless Ferrule (using a P-301 Delrin Nut)		
2.5mm OD Tubing	FEP	650 psi (45 bar)
P-353 Flangeless Ferrule (using a P-307 Delrin Nut)		
3.0mm OD Tubing	FEP	500 psi (34 bar)
P-343 Flangeless Ferrule (using a P-301 Delrin Nut)		
4.0mm OD Tubing	FEP	250 psi (17 bar)
P-139 Flangeless Ferrule (using a P-132 PEEK Nut)		

These tests were performed at room temperature with water testing the fitting, NOT the tubing. The material of the nut, ferrule, tubing and port can affect your results.

*For higher pressures, use a Super Flangeless™ Nut and Ferrule from page 18 or 19 with this sleeve.

METRIC FLANGELESS FITTINGS FOR 1.0mm OD TUBING Qty.

F-252x	Tubing Sleeves, 1/16" OD for 1.0mm only	Purple Teflon FEP	10-pk
P-207x	Flangeless Nuts, M6	Black Delrin	10-pk
P-207S	Short Flangeless Nut, M6	Black Delrin	ea.
P-226x	Flangeless Nuts, M6	Black Teflon PFA	10-pk
P-247x	Short Flangeless Nuts, M6	Black PEEK	10-pk
P-288	Headless Flangeless Nut, M6	Black PPS	ea.

METRIC FLANGELESS FITTINGS FOR 1.8, 2.0, 2.5, 3.0 & 4.0mm OD TUBING¹

P-139	Flangeless Ferrule for 4.0mm only ¹	Natural Kel-F	ea.
P-307x	Flangeless Nuts, M6	Black Delrin	10-pk
P-307S	Short Flangeless Nut, M6	Black Delrin	ea.
P-326x	Flangeless Nuts, M6	Black Teflon PFA	10-pk
P-342x	Flangeless Ferrules for 1.8-2.0mm only	Green ETFE	10-pk
P-343x	Flangeless Ferrules for 3.0mm only	Orange ETFE	10-pk
P-347x	Short Flangeless Nuts, M6	Black PEEK	10-pk
P-353x	Flangeless Ferrules for 2.5mm only	Natural ETFE	10-pk
P-362x	Short Headless Flangeless Nuts, M6	Black PEEK	10-pk

VACUTIGHT™ FITTINGS AND UNION

For Flat-Bottom Ports

* For 1/16" and 1/8" OD Tubing 10-32, 1/4-28 and M6 Threads

* Improve Transfer Volume Consistency

Upchurch Scientific® VacuTight Fittings are designed to provide airtight, dependable connections under vacuum and low pressure conditions. Many of the VacuTight Nuts have streamlined profiles for use in systems requiring a large number of connections in a small area. Furthermore, the VacuTight Ferrule's small size ensures sufficient nut/thread engagement, even in shallow ports. These features make VacuTight Fittings ideal for combichem, high throughput screening, clinical diagnostic and other automated liquid handling applications.

VacuTight Fittings are available for flat-bottom 10-32, 1/4-28 and M6 threaded ports. The configuration of the VacuTight flat-bottom ferrules prevents overcompression and tubing ID reduction that can occur with coned fittings. The result is more consistent aspirating and dispensing volumes across all system connections.

The 10-32 VacuTight Fittings are for use with 1/16" OD tubing. The 1/4-28 and M6 fittings are available for use with both 1/16" and 1/8" OD tubing. All VacuTight Nuts must be used exclusively with VacuTight Ferrules.

VacuTight Nuts with hex heads can be tightened with a standard 1/4" wrench. All VacuTight Nuts with knurls (finger grip ridges) can be tightened finger tight. Additionally, some of the standard head and headless nuts can be tightened with our Extender Tools. We recommend tool tightening no more than 1/2 turn past finger tight.

Use any of the 10-32 fittings on this page to make an inline connection with our VacuTight Union. This product is designed for use with 1/16" OD tubing. Or, use your choice of 1/4-28 or M6 VacuTight Fittings with the appropriate union make an inline connection with 1/16" or 1/8" OD tubing.

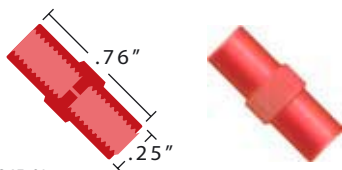

P-845-01
PEEK Union
(10-32 internal threads)

Vacuum and Pressure Rating Table^{1,2}:

Tubing	Vacuum Rating	Pressure Rating	
P-840 VacuTight Ferrule for 1/16" OD Tubing (using a P-938 PEEK Nut)	PFA, .020" ID	25 in. Hg	400 psi (27 bar)
	ETFE, .010" ID	25 in. Hg	800 psi (55 bar)
P-940 VacuTight Ferrule for 1/8" OD Tubing (using P-948 PEEK Nut)	PFA, .062" ID	25 in. Hg	500 psi (34 bar)
	ETFE, .062" ID	25 in. Hg	1,000 psi (69 bar)

¹ This chart is intended for reference only and refers to the pressure rating of the fittings, NOT the tubing. Tests were conducted with room temperature water as the solvent. Your results may vary depending on nut, port and tubing materials, actual tubing diameters (with manufacturer's tolerances), chemical compatibility, etc.
² The nuts were finger tightened for these tests. In some cases, improved results can be obtained by using the tools mentioned above.

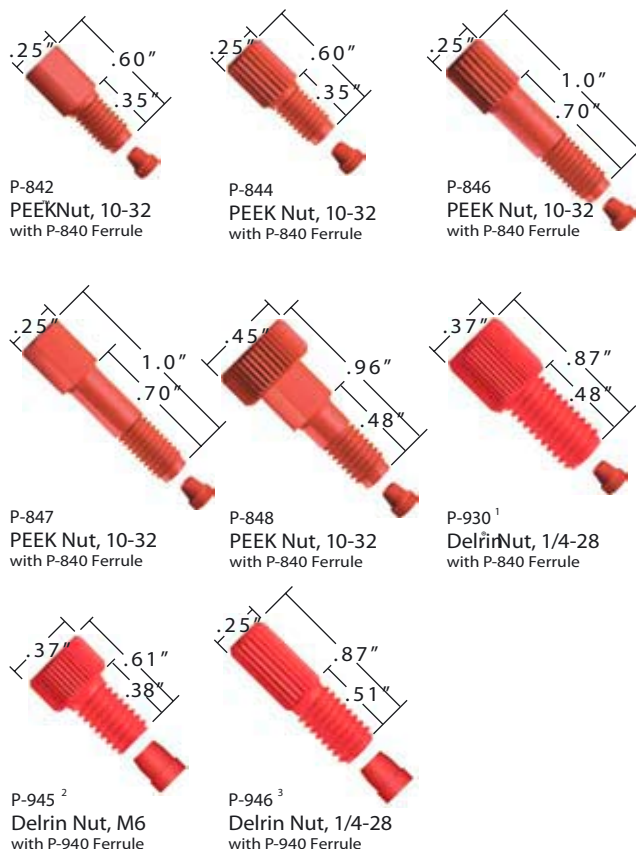

¹ The dimensions shown apply to P-930, P-931, P-938, P-942, P-943 and P-948.
² The dimensions shown apply to P-932, P-933, P-944 and P-945.
³ The dimensions shown apply to P-934, P-935, P-946 and P-947.

VACUTIGHT FERRULES		Qty.
P-840x	VacuTight Ferrules for 1/16" OD tubing, Red ETFE	10-pk
P-940x	VacuTight Ferrules for 1/8" OD tubing, Red ETFE	10-pk

VACUTIGHT NUTS FOR 1/16" OD TUBING (Each includes 10 P-840 Ferrules)		
P-842x	Short Hex Head Nuts, 10-32, Red PEEK	10-pk
P-844x	Short Headless Nuts, 10-32, Red PEEK*	10-pk
P-846x	Long Headless Nuts, 10-32, Red PEEK*	10-pk
P-847x	Long Hex Head Nuts, 10-32, Red PEEK	10-pk
P-848x	Long Knurl/Hex Fathead Nuts, 10-32, Red PEEK	10-pk
P-930x	Std. Length Std. Head Nuts, 1/4-28, Red Delrin*	10-pk
P-931x	Std. Length Std. Head Nuts, M6, Red Delrin	10-pk
P-932x	Short Std. Head Nuts, 1/4-28, Red Delrin	10-pk
P-933x	Short Std. Head Nuts, M6, Red Delrin	10-pk
P-934x	Std. Length Headless Nuts, 1/4-28, Red Delrin	10-pk
P-935x	Std. Length Headless Nuts, M6, Red Delrin	10-pk
P-938x	Std. Length Std. Head Nuts, 1/4-28, Natural PEEK*	10-pk

VACUTIGHT NUTS FOR 1/8" OD TUBING (Each includes 10 P-940 Ferrules)		
P-942x	Std. Length Std. Head Nuts, 1/4-28, Red Delrin*	10-pk
P-943x	Std. Length Std. Head Nuts, M6, Red Delrin	10-pk
P-944x	Short Std. Head Nuts, 1/4-28, Red Delrin	10-pk
P-945x	Short Std. Head Nuts, M6, Red Delrin	10-pk
P-946x	Std. Length Headless Nuts, 1/4-28, Red Delrin	10-pk
P-947x	Std. Length Headless Nuts, M6, Red Delrin	10-pk
P-948x	Std. Length Std. Head Nuts, 1/4-28, Natural PEEK*	10-pk

VACUTIGHT UNION WITH 10-32 THREADS		Swept Volume
P-845-01	PEEK Union for 1/16" OD Tubing, Red .020" (.50mm) thru-hole	.20µL

* These nuts can be tightened with our Extender Tools (see page 56).

Upchurch® LOW PRESSURE FITTINGS & CONNECTORS



Flanged Fittings, Plugs and Caps

FLANGED FITTINGS

For Flat-Bottom Ports

* **Interchangeable with Cheminert® and Omnifit® Fittings**

Upchurch Scientific® 1/4-28 Flanged Fittings are compatible with all standard flanged fittings. The hard, inert Delrin® (acetal resin) nut resists cross threading or loosening during use, while the Tefzel® (ETFE) nuts work well in chemically aggressive environments. The nuts are interchangeable with Cheminert and Omnifit fittings.

Each color-coded Flanged Fitting is shipped with a stainless steel washer to ensure a good seal and firm connection in any flat-bottom port. For an alternative to flanging tubing, we highly recommend the Flangeless Fittings, the Flangeless SealTight™ Fittings, the Super Flangeless™ Fittings, or the VacuTight™ Fittings.

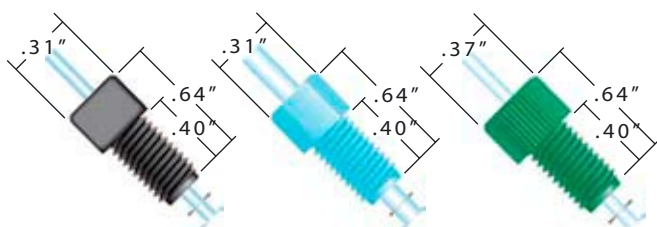

P-401¹
Flanged Fitting
for 1/16" OD tubing*

P-580B²
Flanged Fitting
for 1/8" OD tubing*

P-482G³
Flanged Fitting
for 1/16" OD tubing*

¹ The dimensions shown apply to all square-head Flanged Fittings

² The dimensions shown apply to all hex-head Flanged Fittings

³ The dimensions shown apply to all knurled-head Flanged Fittings

*Flanged tubing not included

PLUGS AND CAPS

For Coned and Flat-Bottom Ports

Seal 10-32, 1/4-28, M6 and 5/16-24 Threaded Ports or Fittings

Use Upchurch Scientific plugs to close off unused ports in valves and multi-port connectors. Our color-coded 10-32 threaded plugs are perfect for identifying stored columns that have different packing materials, or in which different mobile phases have been utilized. Cap off tubing with one of the ETFE caps presented on this page and the appropriate fittings from this chapter or the High Pressure chapter.

To help determine which plug or cap is best suited for your application, please refer to the polymer information presented, or visit www.upchurch.com for detailed chemical compatibility data.

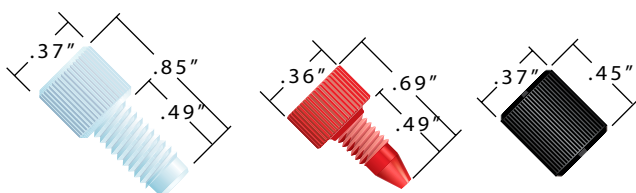

P-316
Teflon® PFA Plug
for 1/4-28 flat-bottom ports

U-467R
Delrin Column Plug
for 10-32 coned ports

P-755
ETFE Cap
for 1/4-28 flat-bottom fittings

FLANGED FITTINGS, 1/4-28¹

For 1/16" OD ²	For 1/8" OD ²	Head Style	Color/Material	Qty.
P-401x	P-501x	Square	Black Delrin	10-pk
P-402x	P-502x	Square	Red Delrin	10-pk
P-403x	P-503x	Square	White Delrin	10-pk
P-404x	P-504x	Square	Cream Delrin	10-pk
P-405x	P-505x	Square	Green Delrin	10-pk
P-406x	P-506x	Square	Blue Delrin	10-pk
	P-508x	Square	Gray Delrin	10-pk
P-480B	P-580B	Hex	Blue Delrin	ea.
P-480BLK	P-580BLK	Hex	Black Delrin	ea.
P-480C	P-580C	Hex	Cream Delrin	ea.
P-480G	P-580G	Hex	Green Delrin	ea.
	P-580GRY	Hex	Gray Delrin	ea.
P-480R	P-580R	Hex	Red Delrin	ea.
P-480T	P-580T	Hex	Natural ETFE	ea.
P-480W	P-580W	Hex	White Delrin	ea.
P-482B	P-582B	Knurled	Blue Delrin	ea.
P-482BLK	P-582BLK	Knurled	Black Delrin	ea.
P-482C	P-582C	Knurled	Cream Delrin	ea.
P-482G	P-582G	Knurled	Green Delrin	ea.
	P-582GRY	Knurled	Gray Delrin	ea.
P-482R	P-582R	Knurled	Red Delrin	ea.
P-482T	P-582T	Knurled	Natural ETFE	ea.
P-482W	P-582W	Knurled	White Delrin	ea.
P-407x	P-507x		Stainless Steel Washers	10-pk

PLUGS

		Color/Material	Qty.
P-120	For 1/4-28 coned ports ³	Natural Kel-F®	ea.
P-123	For 1/4-28 flat-bottom ports ⁴	Natural ETFE	ea.
P-309x	For 1/4-28 flat-bottom ports	Black Delrin	10-pk
P-311	For 1/4-28 flat-bottom ports	Natural ETFE	ea.
P-314	For M6 flat-bottom ports	Black ETFE	ea.
P-314N	For M6 flat-bottom ports	Natural ETFE	ea.
P-316	For 1/4-28 flat-bottom ports	Natural Teflon PFA	ea.
P-321	For 1/4-28 flat-bottom ports ⁵	Natural PEEK™	ea.
P-520	For 10-32 coned ports ⁴	Stainless Steel	ea.
P-550	Extra Long for 10-32 coned ports	Natural PEEK	ea.
P-551	For 10-32 coned ports	Natural PEEK	ea.
P-556	For 5/16-24 flat-bottom ports ⁴	Natural PEEK	ea.
P-557	For 5/16-24 flat-bottom ports ⁴	White Delrin	ea.
P-849	For 10-32 flat-bottom ports	Black Delrin	ea.
U-467Bx	For 10-32 coned ports	Blue Delrin	10-pk
U-467BLKx	For 10-32 coned ports	Black Delrin	10-pk
U-467DBx	For 10-32 coned ports	Dark Blue Delrin	10-pk
U-467Rx	For 10-32 coned ports	Red Delrin	10-pk
U-467Wx	For 10-32 coned ports	White Delrin	10-pk
U-468Bx	For 10-32 coned ports	Blue ETFE	10-pk
U-468BLKx	For 10-32 coned ports	Black ETFE	10-pk
U-468Nx	For 10-32 coned ports	Natural ETFE	10-pk

CAPS

		Color/Material	Qty.
P-754	For use with 10-32 coned fittings	Yellow ETFE	ea.
P-755	For use with 1/4-28 flat-bottom fittings	Black ETFE	ea.
P-756	For use with M6 flat-bottom fittings	Blue ETFE	ea.

¹ Each Flanged Fitting comes with the appropriate Stainless Steel Washer.

² The size of tubing for which the fittings in the column are designed.

³ For 1/8" OD tubing.

⁴ Hex head (5/16").

⁵ FlushNut™ style. Use a flat-head screwdriver or our F-346 Tool on page 56 to tighten.



LARGE BORE FITTINGS

For Flat-Bottom and Coned Ports

- * 5/16-24 and 1/2-20 Threads
- * For Use with 1/16", 1/8", 3/16", 1/4", 5/16" and 4.0mm OD Tubing

Upchurch Scientific® Large Bore Fittings are perfect for higher flow applications, such as preparative valves and some solvent inlet flow connections.

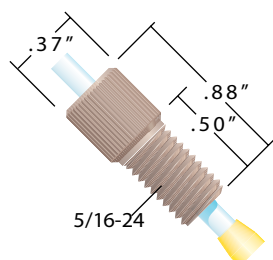

P-130
PEEK™ Nut, for 1/8" OD tubing
shown with P-300 Flangeless Ferrule

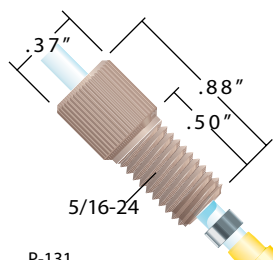

P-131
PEEK Nut, for 1/8" OD tubing
shown with P-359 Super Flangeless™ Ferrule

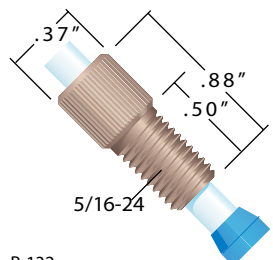

P-132
PEEK Nut, for 3/16" and 4.0mm OD tubing
shown with P-133 Flangeless Ferrule

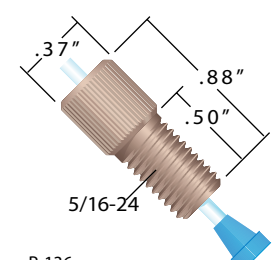

P-136
PEEK Nut, for 1/16" OD tubing
shown with P-200 Flangeless Ferrule

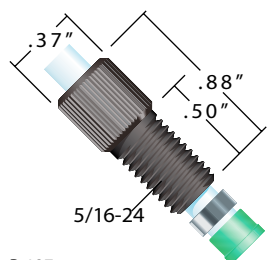

P-137
PEEK Nut, for 3/16" and 4.0mm OD tubing
shown with P-140 Super Flangeless
Ferrule (this page)

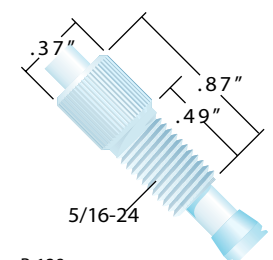

P-138
Delrin™ Nut, for 3/16" and 4.0mm OD tubing
shown with P-139 Flangeless Ferrule

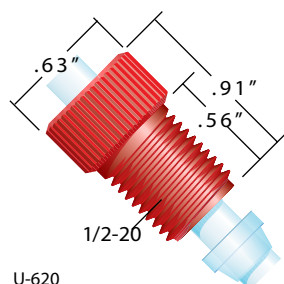

U-620
PEEK Nut, for 1/4" OD tubing
shown with inverted U-650 Flangeless Ferrule
for coned ports (this page)

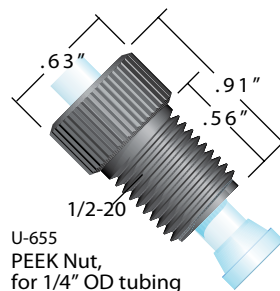

U-655
PEEK Nut,
for 1/4" OD tubing
shown with U-650
Flangeless Ferrule (this page)

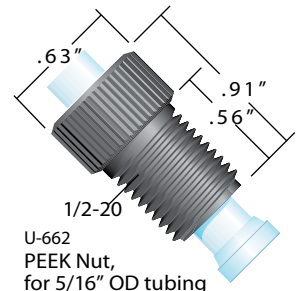

U-662
PEEK Nut,
for 5/16" OD tubing
shown with U-660
Flangeless Ferrule (this page)

LARGE BORE UNIONS

- * 5/16-24 and 1/2-20 Threads

Use any of the 5/16-24 nuts on this page and the appropriate ferrule to create a true zero dead volume (ZDV) connection with the P-134 Union. Our U-658 and U-664 Unions are designed to be used with our standard 1/2-20 flat-bottom threaded nuts and ferrules.

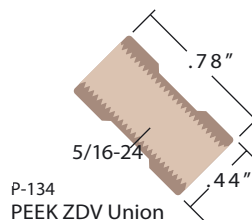

P-134
PEEK ZDV Union

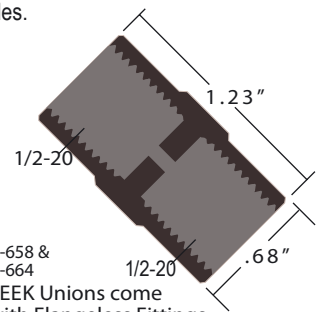

U-658 &
U-664
PEEK Unions come
with Flangeless Fittings

More Large Bore Products:

	Page		Page
5/16-24 Coned Fittings	12, 15	Teflon® Tubing	71, 72
Barbed Adapters	48, 49	Tubing Cutter	77
Threaded Adapters	50, 52, 53	Pressure Relief Valve	110
Plugs	60	Solvent Inlet Filters	115-117
Y Connector	63	Bottle Caps	120
Tefzel® (ETFE) Tubing	70	Semi-Prep Inline Filters	124

LARGE BORE FLANGELESS FERRULES Qty.

P-133	ETFE Flangeless Ferrule for 3/16" OD tubing, Blue	ea.
P-133N	ETFE Flangeless Ferrule for 3/16" OD tubing, Natural	ea.
P-140x	ETFE Super Flangeless Ferrule for 3/16" OD tubing ¹ , Green	10-pk
U-650x	ETFE Flangeless Ferrules for 1/4" OD tubing, Natural	10-pk
U-660x	ETFE Flangeless Ferrules for 5/16" OD tubing, Natural	10-pk

LARGE BORE FLANGELESS NUTS Qty.

P-130	PEEK Nut for 1/8" OD tubing ² , 5/16-24, Natural	ea.
P-131	PEEK Nut for 1/8" OD tubing ² , 5/16-24, Natural	ea.
P-132	PEEK Nut for 3/16" and 4.0mm OD tubing, 5/16-24, Natural	ea.
P-136	PEEK Nut for 1/16" OD tubing, 5/16-24, Natural	ea.
P-137	PEEK Nut for 3/16" and 4.0mm OD tubing ¹ , 5/16-24, Black	ea.
P-138	Delrin Nut for 3/16" and 4.0mm OD tubing, 5/16-24, Natural	ea.
U-620x	PEEK Nuts for 1/4" OD tubing, 1/2-20 Coned, Red	10-pk
U-655x	PEEK Nuts for 1/4" OD tubing, 1/2-20, Black	10-pk
U-662x	PEEK Nuts for 5/16" OD tubing, 1/2-20, Black	10-pk

LARGE BORE UNIONS

	Swept Volume	
P-134	PEEK ZDV Union, 5/16-24, Natural	NA
U-658	PEEK Union for 1/4" OD tubing, 1/2-20, Black .188" (4.8mm) thru-hole, includes (2) U-650/U-655 Fittings	57µL
U-664	PEEK Union for 5/16" OD tubing, 1/2-20, Black .188" (4.8mm) thru-hole, includes (2) U-660/U-662 Fittings	57µL

¹ Use P-137 Nuts with P-140 Ferrules.

² For 1/8" Flangeless Ferrules.

³ For 1/8" Super Flangeless or LiteTouch® Ferrules.

LOW PRESSURE UNIONS

* **Manufactured from PEEK™, Tefzel® (ETFE), Delrin®, Polypropylene and Kel-F® (PCTFE)**

Upchurch Scientific® Low Pressure Unions are available in a variety of polymers, providing several low-cost and chemically-resistant options. PEEK unions have excellent chemical resistance to organic and inorganic liquids. ETFE polymer is also very resistant to chemical attack (except by chlorinated solvents). Delrin has excellent chemical resistance to most organic chemicals and neutral pH aqueous solvents; however, it should NOT be used with acids or bases. Polypropylene offers a low-cost alternative with marginal chemical resistance, while PCTFE offers very good chemical compatibility and durable threading.

Low Pressure PEEK Union Assemblies

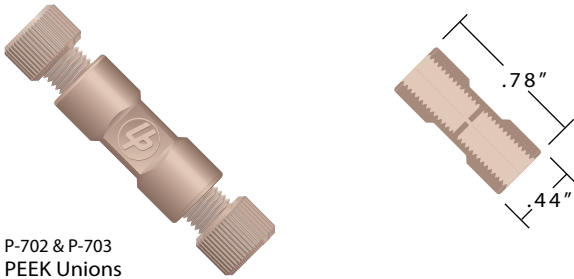

P-702 & P-703
PEEK Unions
with Flangeless Fittings
(1/4-28 internal threads)

Low Pressure ETFE Union Assemblies

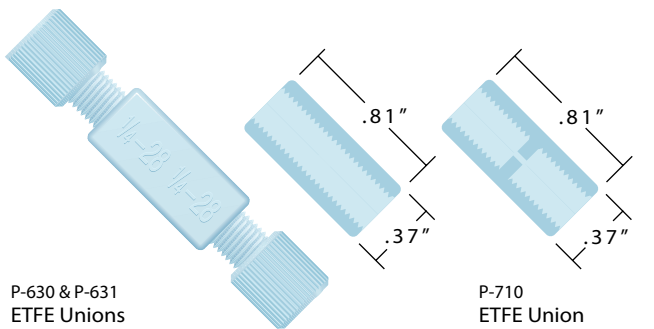

P-630 & P-631
ETFE Unions
with Flangeless Fittings
(1/4-28 internal threads)

P-710
ETFE Union
with Flangeless Fittings
(1/4-28 internal threads)

Low Pressure Standard Union

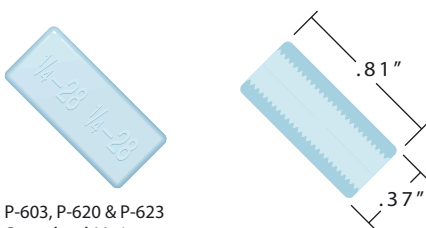

P-603, P-620 & P-623
Standard Unions
(1/4-28 internal threads)

Low Pressure Metric Union

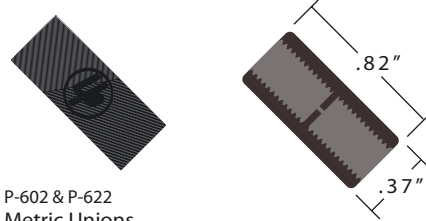

P-602 & P-622
Metric Unions
(M6 internal threads)

Low Pressure Male Union

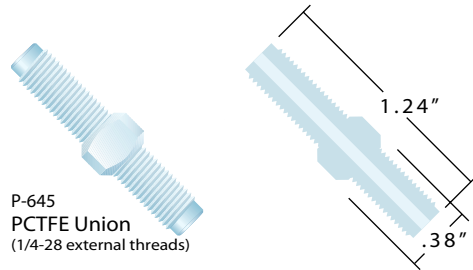

P-645
PCTFE Union
(1/4-28 external threads)

Note

>> Use soft tubing, made from DuPont Teflon® brand resin, or ETFE, when using ETFE unions with ETFE nuts and ferrules.

>> Please refer to page 59 for our VacuTight™ Union (10-32 flat-bottom) for large bore unions (5/16-24 and 1/2-20).

>> Our 10-32 to 10-32 Column Couplers are listed.

PEEK UNION ASSEMBLIES, 1/4-28 THREADS

Part Number	Description	Material	Swept Volume
P-702	PEEK Webbed Union for 1/16" OD tubing .020" (.50mm) thru-hole, includes (2) P-200/P-235	Natural	.41µL
P-703	PEEK Webbed Union for 1/8" OD tubing .050" (1.25mm) thru-hole, includes (2) P-300/P-335	Natural	2.57µL

ETFE UNION ASSEMBLIES, 1/4-28 THREADS

P-630	ETFE ZDV Union for 1/16" OD tubing Includes (2) P-200N/P-245	Natural	N/A
P-631	ETFE ZDV Union for 1/8" OD tubing Includes (2) P-300N/P-345	Natural	N/A
P-710	ETFE Webbed Union for 1/16" OD tubing .030" (.75mm) thru-hole, includes (2) P-200/P-245	Natural	.93µL

STANDARD UNIONS, 1/4-28 THREADS

P-603	Delrin Standard Union ¹	Natural	N/A
P-620	Polypropylene Standard Union ¹	Natural	N/A
P-623	ETFE Standard Union ¹	Natural	N/A

METRIC UNIONS, M6 THREADS

P-602	Delrin Metric Webbed Union ¹ .020" (.50mm) thru-hole	Black	.41µL
P-622	ETFE Metric Webbed Union ¹ .020" (.50mm) thru-hole	Blue	.41µL

MALE UNION, 1/4-28 THREADS

P-645	PCTFE Male Union ¹ .062" (1.60mm) thru-hole	Natural	61.3µL
-------	---	---------	--------

¹ No fittings included.



BULKHEAD UNIONS

- * Designed for Plumbing Tubing through Equipment Housing
- * For Use with Standard 1/4-28, 10-32 and M6 Threaded Fittings

Thread Upchurch Scientific® PEEK™ Bulkhead Unions directly through your equipment housing to connect internal tubing to the outside. Each union has 3/8-24 external threads and comes complete with a stainless steel nut and lock washer to hold it in place. Requires a 3/8" hole to mount. The recommended torque limit for these unions is 15 in.-lbs.

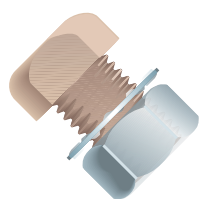

Bulkhead Union includes stainless steel nut/lock washer

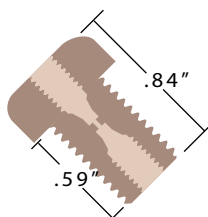

P-440 10-32 internal threads

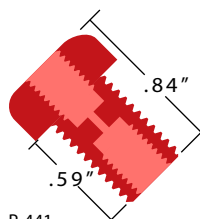

P-441 1/4-28 internal threads

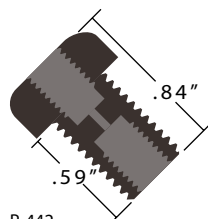

P-442 M6 internal threads

ELBOW CONNECTORS

Use these Elbow Connectors to easily navigate tight corners. One Elbow is designed for use with 1/16" OD tubing and has a .020" thru-hole. Use 1/8" OD tubing with the other Elbow, which has a .062" thru-hole. Both come complete with 1/4-28 PEEK nuts and Tefzel® (ETFE) ferrules, and are pressure rated to 1,000 psi (69 bar).

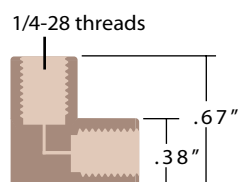

P-430 PEEK Elbow comes with Flangeless Fittings



Y CONNECTORS

Upchurch Scientific PEEK Y Connectors are designed to split a stream or join two streams together, just like a tee. However, the configuration of a tee can lead to turbulent flow and solvent outgassing, which increases baseline noise and reduces sensitivity. The geometry of a Y connector creates much less turbulence and thus can improve analytical results.

All of our Y Connectors use 1/4-28 Flangeless Fittings, except P-515 which uses 5/16-24 fittings. The maximum recommended pressure for all Connectors is 1,000 psi (69 bar).

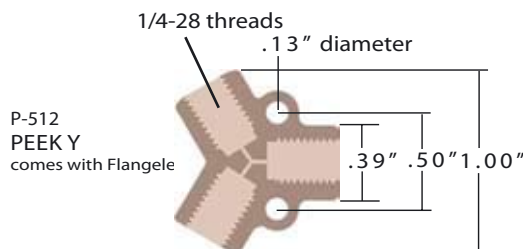

P-512 PEEK Y comes with Flangeless

BULKHEAD UNIONS¹

	Color/Material	Thru-hole	Internal threads	Swept Volume
P-440	Natural PEEK	.020" (.50mm)	10-32	1.9µL
P-441	Red PEEK	.040" (1.00mm)	1/4-28	2.9µL
P-441N	Natural PEEK	.040" (1.00mm)	1/4-28	2.9µL
P-442	Black PEEK	.040" (1.00mm)	M6	2.9µL

ELBOW CONNECTORS

	Color/Material	Thru-hole	Tubing OD	Includes:	Swept Volume
P-430	Natural PEEK	.020" (.50mm)	1/16"	P-235/P-200	1.4µL
P-432	Natural PEEK	.062" (1.60mm)	1/8"	P-335/P-300	13.6µL

Y CONNECTORS

	Color/Material	Body Thru-hole	Tubing OD	Includes:	Swept Volume
P-512	Natural PEEK	.020" (.50mm)	1/16"	P-235/P-200	1.7µL
P-513	Natural PEEK	.040" (1.00mm)	1/8"	P-335/P-300	6.0µL
P-514	Natural PEEK	.060" (1.50mm)	1/8"	P-335/P-300	13.6µL
P-515	Natural PEEK	.125" (3.20mm)	3/16"	P-133/P-132	47.7µL

¹ Each Bulkhead Union comes complete with a stainless steel nut and lock washer.

Note

>> Stainless Steel Bulkhead Unions are also available. Please contact us for more information.

>> To use Elbows or Y Connectors in higher pressure applications, simply replace the provided fittings with Super Flangeless™ Nuts and Ferrules.

TEES AND CROSSES

Upchurch Scientific® Tees and Crosses are available in two inert polymers and can handle pressures to 1,000 psi (69 bar). Each is designed with handy mounting holes. All Tefzel® (ETFE) Tees and Crosses ship complete with 1/4-28 PFA Teflon® Flangeless nuts and ETFE ferrules, while their PEEK™ polymer counterparts ship with 1/4-28 PEEK nuts and ETFE ferrules.

Our Tees and Crosses with .020" thru-holes (1/16" OD tubing versions) offer very low swept volumes, making them desirable for post-injector connections in low pressure systems. Larger .040" and .050" thru-hole products offer passageways for higher flow applications with minimal flow path resistance.

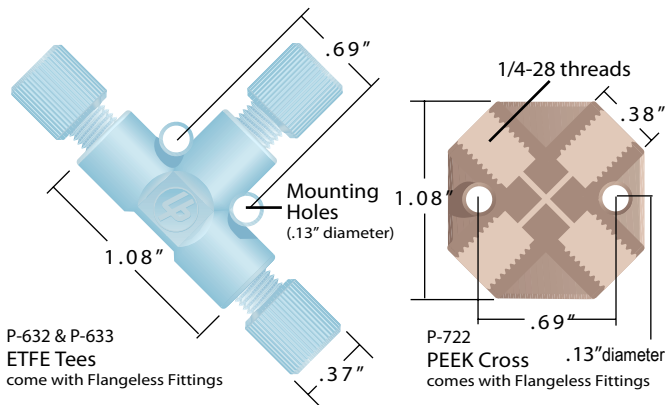

Note

>> Seal off unused ports with any of our 1/4-28 flatbottom plugs.

>> To use the PEEK polymer versions of our Tees and Crosses in higher pressure applications, simply replace the provided fittings with Super Flangeless Nuts and Ferrules.

>> High Pressure Tees, Crosses and a 7-Port Manifold (all with 10-32 threaded ports).

MANIFOLDS

Choose a 5, 6, 7 or 9 Port Manifold to combine several streams into one, or split one fluid stream into several. Each PEEK manifold comes complete with 1/4-28 Super Flangeless™ Fittings for either 1/16" or 1/8" OD tubing, with pressure ratings of 5,000 psi (345 bar) and 1,000 psi (69 bar), respectively.

Bulkhead mountable 6-Port versions are available, and come with a stainless steel nut and lock washer to hold them in place. These manifolds have 1/2-20 external threads, requiring a 1/2" diameter hole to mount. The recommended torque limit for these products is 15in.-lbs.

A few useful applications include: multiport mixing chamber, gas sparging splitting union, sample injection onto multi-well plates, or a multiple direction flow path union.

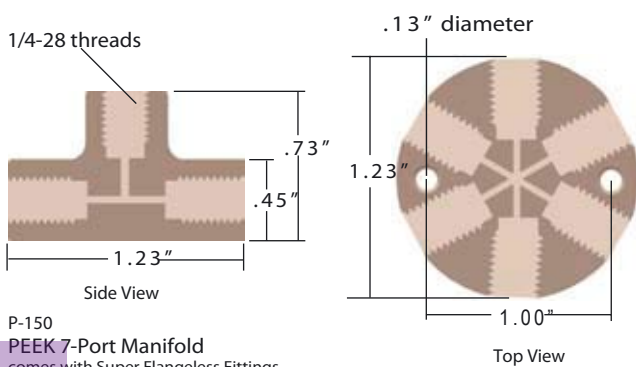

TEES AND CROSSES

	Type	Material	Thru-hole	Tubing OD	Includes:	Swept Volume
P-632	Tee	ETFE	.020" (.50mm)	1/16"	P-245/P-200N	2.9µL
P-633	Tee	ETFE	.050" (1.25mm)	1/8"	P-345/P-300N	17.5µL
P-634	Cross	ETFE	.020" (.50mm)	1/16"	P-245/P-200N	3.8µL
P-635	Cross	ETFE	.050" (1.25mm)	1/8"	P-345/P-300N	22.8µL
P-712	Tee	PEEK	.020" (.50mm)	1/16"	P-235/P-200	2.9µL
P-713	Tee	PEEK	.050" (1.25mm)	1/8"	P-335/P-300	17.5µL
P-714	Tee	PEEK	.040" (1.00mm)	1/16"	P-235/P-200	11.4µL
P-722	Cross	PEEK	.020" (.50mm)	1/16"	P-235/P-200	3.8µL
P-723	Cross	PEEK	.050" (1.25mm)	1/8"	P-335/P-300	22.8µL

MANIFOLDS¹

Standard						
P-150	7-Port	PEEK	.040" (1.00mm)	1/16"	P-255/P-250	42.0µL
P-151	7-Port	PEEK	.062" (1.60mm)	1/8"	P-331/P-359	83.0µL
P-152	6-Port	PEEK	.040" (1.00mm)	1/16"	P-255/P-250	26.8µL
P-153	6-Port	PEEK	.062" (1.60mm)	1/8"	P-331/P-359	62.3µL
P-154	5-Port	PEEK	.040" (1.00mm)	1/16"	P-255/P-250	22.3µL
P-155	5-Port	PEEK	.062" (1.60mm)	1/8"	P-331/P-359	53.8µL
P-190	9-Port	PEEK	.062" (1.60mm)	1/8"	P-331/P-359	160µL
P-191	9-Port	PEEK	.040" (1.00mm)	1/16"	P-255/P-250	139µL
Bulkhead ²						
P-156	6-Port	PEEK	.040" (1.00mm)	1/16"	P-255/P-250	31.3µL
P-157	6-Port	PEEK	.062" (1.60mm)	1/8"	P-331/P-359	73.2µL

¹ All Manifolds with .040" thru-holes have black PEEK bodies. Those with .062" thru-holes have natural PEEK bodies.

² Bulkhead Manifolds come complete with a stainless steel nut and lock washer.